

# Vereo<sup>TM</sup> Smart

**CONTROL AND MONITOR YOUR  
LASER MARKER FROM ANY DEVICE**

**INTEGRATED LASER MARKING  
WITH SIMPLE CONTROL  
AT YOUR FINGERTIPS**

**TYKMA<sup>TM</sup>  
ELECTROX** 

Industrial Laser Systems

# The Vereo™ Smart is a revolutionary integration laser system.

**A LASER MARKING SOLUTION FOR AUTOMATED PROCESSES WITH A UNIQUE, MODERN CONTROL INTERFACE**



**NO PC? NO PROBLEM!**

**VEREO SMART CAN BE CONTROLLED FROM ANY DEVICE, INCLUDING SMART PHONES, TABLETS, AND PROGRAMMABLE LOGIC CONTROLLERS.**

Vereo Smart is the ultimate tool for manufacturers and integrators requiring a laser marking system for automated lines, assembly cells and more. A maintenance free MOPA fiber laser source up to 50 watts can solve a variety of marking applications. Vereo Smart, equipped with an onboard controller,

features a network interface to access the laser system from any device, for marking program management and modification as well as process monitoring. PLC connectivity for data control is easy to setup using a simple wizard. With a compact footprint, Vereo Smart is a powerful marking tool for any process.

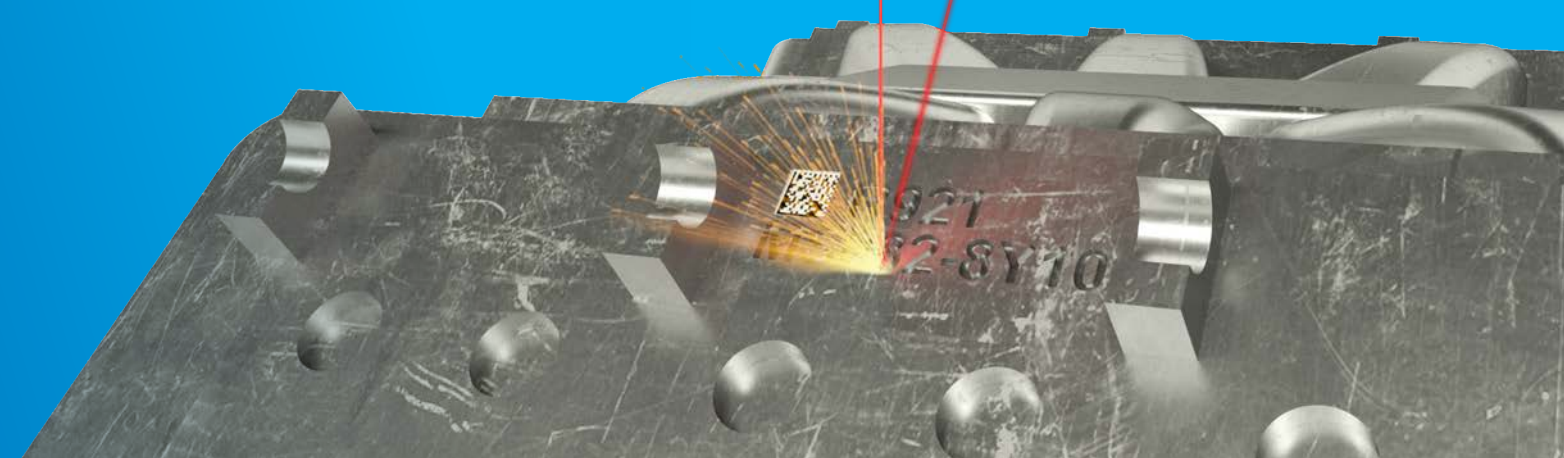



# Power and Flexibility

*Our MOPA fiber laser excels over traditional fiber laser technology. Adjustable pulse durations allow for expanded capabilities and the processing of a wide variety of materials.*

*Vereo Smart marks a variety of metals: Steel, Stainless Steel, Titanium, Aluminum, Brass, Copper, Nickel Plated, Galvanized. Various plastics: ABS, PE, and others. Painted, Coated, Black Oxide and Anodized materials, Carbide, PCD and more.*



## POWER

*Vereo Smart is built for speed. Available in 20W and 50W models.*

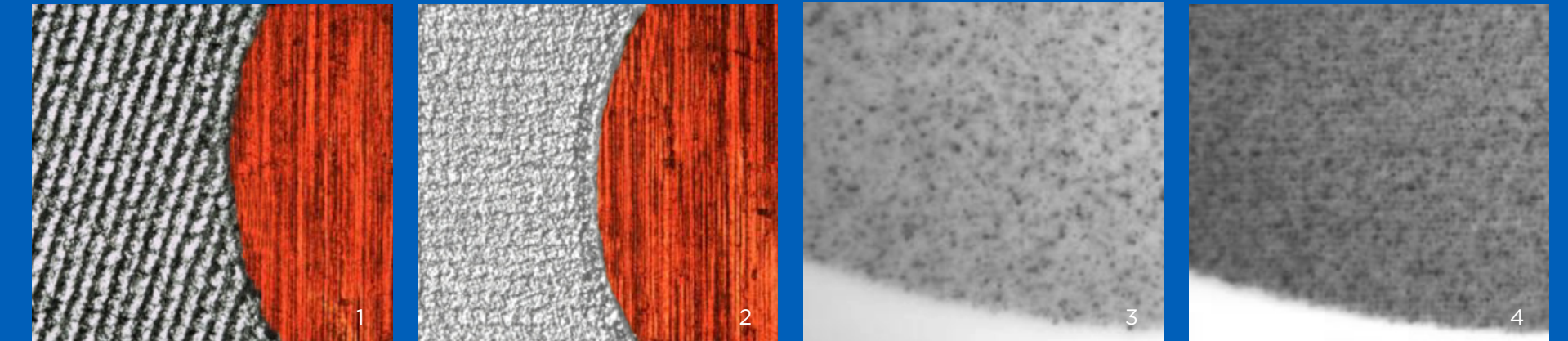

## ABLATION

With anodized aluminum ablation, the results are improved by selecting an optimized waveform in the software, thus lowering the pulse duration and improving the marking results. Figure 1 shows magnified marking results from a standard fiber laser marker. Figure 2 shows magnified marking results from our fiber laser using an optimized waveform, which improves surface finish and brightness, and decreases cycle time.

## PLASTIC FOAMING

With plastics, the results are improved by selecting an optimized waveform in the software, thus lowering the pulse duration and improving the marking results. Figure 3 shows magnified marking results from a standard fiber laser marker. Figure 4 shows magnified marking results from our fiber laser using an optimized waveform, which improves the absorption rate increasing the mark density and contrast.



# Compact and Rugged

*Designed for integrated industrial marking applications*

---

## COMPACT DESIGN

Ultra-compact scan head for small space integration with a 19" rack mount controller.

---

## EMBEDDED CONTROLLER

Vereo Smart operates in standalone mode without the need of an inline or connected PC.

---

## INTEGRATED FOCUS FINDER

Simple focus finder solution enables a quick and easy setup.

---

## INDUSTRY LEADING WARRANTY

A 3 year comprehensive warranty, front to back, top to bottom.

---

## RUGGED BUILT FOR INDUSTRIAL ENVIRONMENTS

A machined anodized aluminum head protects key components from harsh industrial factories where oil, dust and debris are present. Cables are protected using a heavy-duty cable cover. Electronics are isolated from the outside environment.

---

## AIR-COOLED AND MAINTENANCE FREE

Vereo Smart is air cooled and can operate in high ambient temperature environments and requires no routine replacement parts, water chillers, or calibrations required.







# Revolutionary Control



CONTROL, PROGRAM, AND MONITOR VERO SMART FROM ANY DEVICE, WITHOUT THE BURDEN OF INSTALLING ADDITIONAL SOFTWARE.

**Traditional Method:** Engineers and programmers must connect the full marking program editing package to the laser using a Windows based laptop or desktop PC to add, delete or modify programs. Any computers that need to connect to the laser must use the same full marking program editing package. Process monitoring is typically not available.

**Vereo Smart:** Add, modify or delete programs from anywhere on the same network using a variety of devices and operating systems. Gather status and process information on demand. The full marking program editing software can be installed on a PC of your choice and is only required for new program creation or advanced editing.

- PC FREE OPERATION
- CONTROL USING A PC, SMART PHONE OR TABLET
- SECURE CONNECTION WITH USER AUTHENTICATION
- UPLOAD NEW PROGRAMS, MANAGE EXISTING PROGRAMS, VIEW LAYOUTS AND CHANGE MARKING DATA
- MONITOR LASER STATUS AND SYSTEM HEALTH
- VIEW PROCESS STATISTICS
- ACCESS LOG FILES FOR COMPLETE HISTORY TRACKING
- CHANGE SETTINGS, CONFIGURATIONS AND MORE

# Automation Ready

VEREO SMART IS EQUIPPED OUT OF THE BOX FOR QUICK AND EASY INTEGRATION WITH PLCs, DATABASES, AND OTHER DEVICES. SAVE TIME AND MONEY WITH OUR SIMPLIFIED SOLUTIONS.

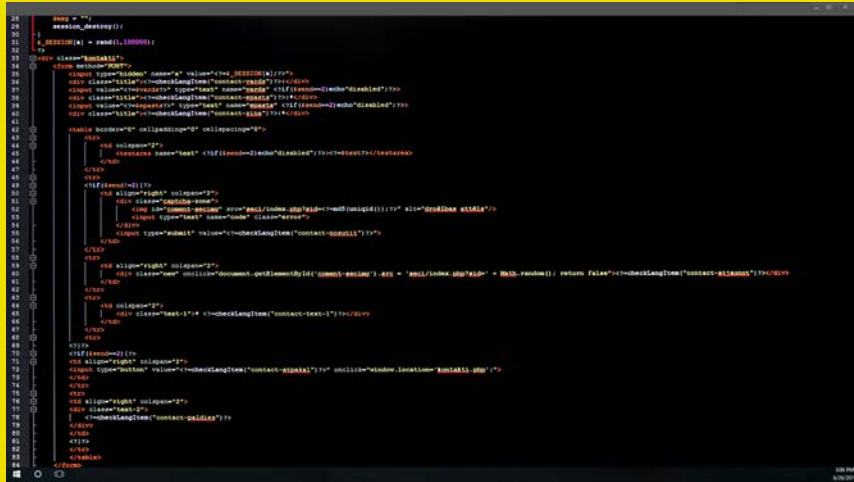

## TRADITIONAL

Data transfer and handshaking between the laser system and PLCs or Databases requires hours of complex programming using an API (Application Programming Interface).

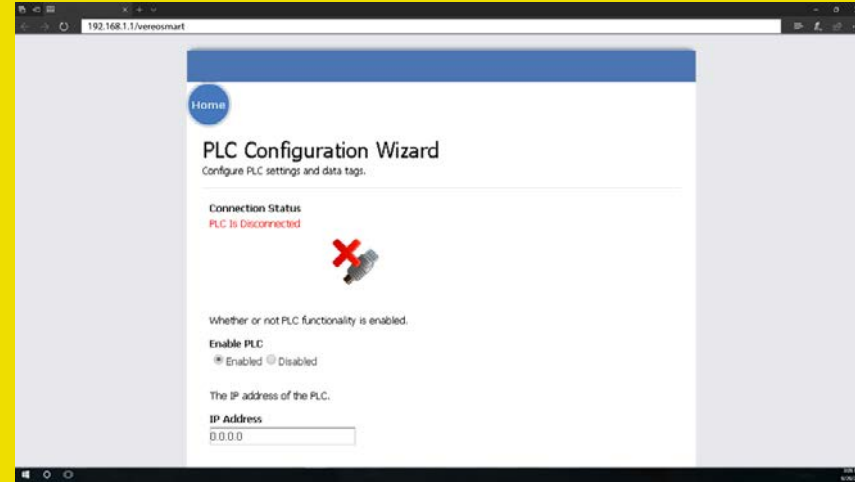

## VEREO SMART

Quickly setup a data transfer handshake between Vereo Smart and common brand PLCs such as AB, Siemens and more, with a simple wizard accessed from any device. A standard TCP/IP command protocol is available for advanced control of Vereo Smart from 3rd party software, databases or devices.

USING A SIMPLE WIZARD, ACCESSED FROM ANY DEVICE, SETUP SEAMLESS CONNECTIVITY TO COMMON BRAND PLCs, SUCH AS AB OR SIEMENS FOR PROGRAM AND MARKING DATA SELECTION

- **TCP/IP INTERFACE** FOR COMPLETE LASER AND MARKING PROGRAM CONTROL VIA NETWORKED SOFTWARE SYSTEMS, DATABASES, AND DEVICES.
- **SERIAL INTERFACE** AVAILABLE FOR INTEGRATION WITH EXISTING PRODUCTION LINES.
- **HMI INTERFACING** ENABLES ENGINEERS TO SETUP LASER CONTROL SCREENS ON THEIR EXISTING PRODUCTION LINE HMI.





# Touch Control

**VEREO SMART FEATURES A FRONT MOUNTED TOUCH SCREEN CONTROLLER FOR QUICK ACCESS TO LASER CONTROL, MARKING PROGRAMS, AND A VARIETY OF FUNCTIONS.**



- FROM THE TOUCHSCREEN:**
- SELECT PROGRAMS, VIEW PROGRAM IMAGE PREVIEWS, CHANGE DATA, AND MORE
  - CHANGE LASER MARKING PARAMETERS FOR SETUP AND MARKING OPTIMIZATION INCLUDING POWER, SPEED, AND FREQUENCY
  - VIEW I/O SCREEN FOR MONITORING PROCESS, DIAGNOSTICS AND INITIAL DISCREET I/O SETUP
  - MONITOR LASER STATUS AND SYSTEM HEALTH
  - CHANGE SETTINGS AND SYSTEM CONFIGURATIONS

# Create Programs with Minilase Pro SE

*Easily create laser programs for use with Vereo Smart with our Minilase Pro SE software package.*

## FEATURES

- MARKING PARAMETER LIBRARY FOR QUICK SETUP
- PASSWORD PROTECTED USER LEVELS
- CAD TOOLS
- VARIOUS HATCH FUNCTIONS
- COLOR CODED LASER PARAMETERS
- EXTERNAL AXIS CONTROL: X, Y, Z AND ROTARY FOR 360° MARKING
- GRAPHIC TILING
- BOUNDING BOX AND OUTLINE RED LASER TRACING
- BASIC AND ADVANCED SHAPES
- VECTOR GRAPHIC LIBRARY
- TRUETYPE FONTS
- BARCODES: CODE39/93, 128, EAN, UPC, 25, ITF25, PDF417, GS1-128
- 2D CODES: DATAMATRIX, GS1 (UDI/UID), QR CODE, MICRO QR CODE, AZTEC CODE
- VECTOR GRAPHICS: PLT (HPGL), DXF, AI, SVG
- IMAGE FILES: JPG, PNG, BMP, TIF, GIF

## System Options and Accessories

- EP ADVANCED WAVEFORM CONTROL FOR MAXIMUM MARKING FLEXIBILITY
- 3D LASER MARKING
- ROTARY DEVICES
- RACK MOUNT SHELF WITH COOLING INLET
- EXTERNAL AXES FOR AUTOMATED MOTION
- FUME AND DUST EXTRACTION UNITS
- LASER SAFETY EYEWARE





# Vereo Technical Specifications

**SYSTEM DIMENSIONS** Head 3.5"W x 16.25"L x 3.56"H / (mm) 88.9W x 412.8L x 90.5H  
 Rack 17"W x 17.49"L x 5.77"H / (mm) 431.8W x 444.3L x 146.5H

**SYSTEM WEIGHT** Head 11lbs / 4.98kg  
 Rack 50lbs / 22.67

**STANDARD MARKING LENS AND FIELD** 160S 3.93" x 3.93" / 100mm x 100mm

**AVAILABLE MARKING LENS** 254S 5.5" x 5.5", 140mm x 140mm  
**UPGRADE AND MARKING FIELDS** (350mm and 410mm available in Scorpeo variant, consult your sales engineer)

**WORKING DISTANCE** 160S 177mm / 254S 280mm (from bottom of lens flange)

**LASER TYPE** Ytterbium Fiber

**WAVELENGTH** 1062nm +/- 3nm

**WATTAGE** 20W / 50W

**FREQUENCY RANGE** 1kHz - 500kHz

**PULSE DURATION** Selectable, 260ns or 40ns

**OPERATIVE AMBIENT TEMPERATURE RANGE** 45° - 97° F / 7° - 36° C

**COOLING** Air Cooled

**FIBER CABLE LENGTH** 3M (from rack to head)

**INPUT POWER** Power Sensing 110-240VAC 50/60Hz

**AIMING BEAM** (2) Class IIIa/3R Red Diode

**PC** Embedded Controller / PC Not Required for Operation

**DATA COMMUNICATION** TCP/IP / RS232 via USB Adapter

**PLC DATA COMMUNICATION** AB and Siemens ready

**AVAILABLE PORTS** Ethernet/USB (2)/Diagnostic/Discrete IO/  
 External Axes/Hardware Interlock

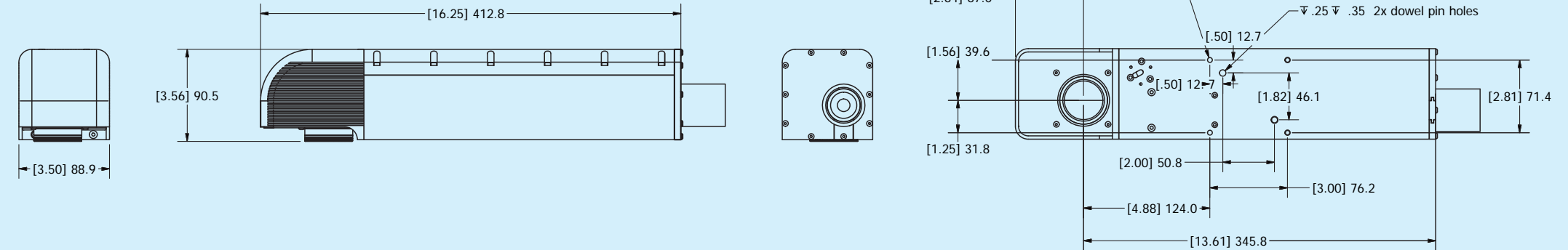
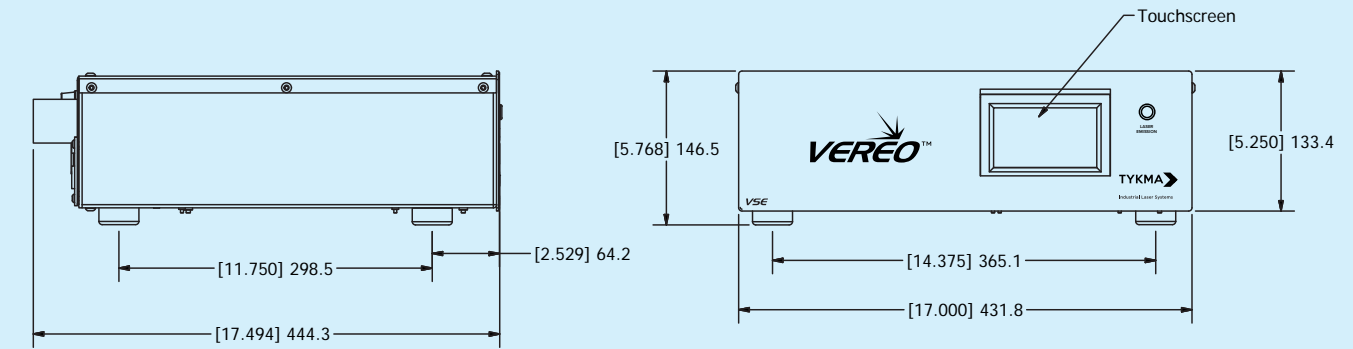
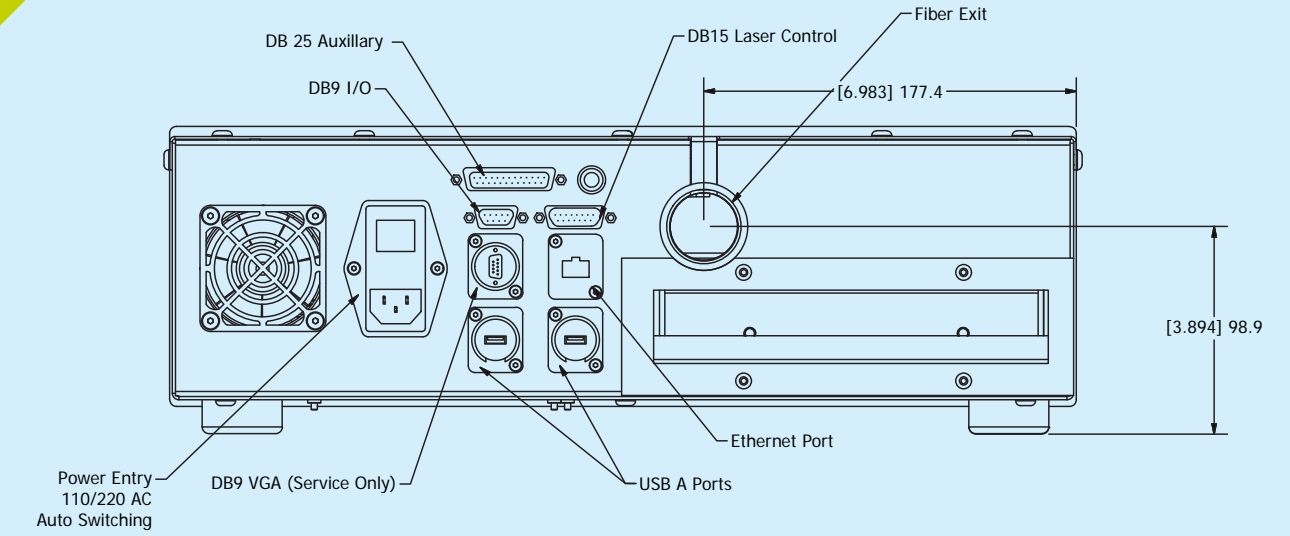

14  
 /  
 15



# About Us

## SOLVING COMPLEX CHALLENGES

Our experience in industrial laser systems enables us to be the industry expert. From the first contact, we work in a consultative style to fully understand our customer's unique requirements. Our application specialists and sales engineers ensure you receive the highest quality systems and performance.

Production is supported by experienced, product identification industry management, highly qualified engineers, software designers, and skilled factory-trained technical service professionals. Every system we build is fully warranted, designed with exacting international standards, and backed by exceptional service, training, and technical support.

## SERVICE AND SUPPORT

TYKMA™ Electroxx pledges to provide every customer with laser systems of the highest quality and reliability. We offer application specialists that are available from the start. Our emergency service line is available 24/7.

“

The lasers from TYKMA are well engineered and nicely finished products. They require little maintenance and are easy to use. The sales and service support are excellent. The few issues we've had were resolved online in minutes with a TYKMA technician. They make it easy.

”

Arthur Jones,  
Director of Manufacturing,  
Royal Products

“

PFL could not be happier with the system we selected, its performance, and your support for our needs. Our new system is 10-20X faster than the older YAG laser system we were using. The flexibility has allowed us to offer a host of value added services that has delighted our customers, and generated additional revenue for us.

“

David Diamond, CEO, Precision Fabricators

## WE ARE SPECIALISTS IN INDUSTRIAL LASER MARKING AND ENGRAVING SYSTEMS.

OUR NUMBER ONE FOCUS IS THE RELATIONSHIP WITH OUR CUSTOMERS, FROM THE INITIAL CONTACT THROUGH THE INSTALLATION OF YOUR LASER SYSTEM AND BEYOND, WE STRIVE TO PROVIDE A PERSONALIZED CONSULTATIVE APPROACH TO SOLVING YOUR APPLICATION.





Industrial Laser Systems

NORTH AMERICA, HEADQUARTERS  
370 GATEWAY DRIVE  
CHILLICOTHE, OHIO 45601  
+1 (740) 779-9918

[SALES@PERMANENTMARKING.COM](mailto:SALES@PERMANENTMARKING.COM)

U.K. FACILITY  
THE NEXUS BUILDING, BROADWAY, LETCHWORTH  
HERTFORDSHIRE SG6 3TA, UNITED KINGDOM  
+44 (0) 1462 688110

[WWW.PermanentMarking.com](http://WWW.PermanentMarking.com)